



LOCATOR® ATTACHMENT SYSTEM **TECHNIQUE MANUAL**

LOCATOR IMPLANT, BAR, AND ROOT ATTACHMENTS

TABLE OF CONTENTS

1	THE LOCATOR® COMPONENT REFERENCE LIST
2	LOCATOR - THE GOLD STANDARD IMPLANT ATTACHMENT SYSTEM
3	LOCATOR - A FAMILY OF SOLUTIONS
4	LOCATOR STANDARD & EXTENDED RANGE MALES
5	LOCATOR 3-IN-1 CORE TOOL
6	LOCATOR IMPLANT ATTACHMENT SYSTEM
6	Abutment and Replacement Male Selection
7	Abutment Placement
8	PROCESSING LOCATOR DENTURE CAP INTO THE OVERDENTURE
8	Direct Technique
11	Indirect Technique
14	LOCATOR BAR ATTACHMENT SYSTEM
14	Drill and Tap
16	Castable Threaded Insert
18	Laser Weld
20	Cast-To Bar
22	LOCATOR ROOT ATTACHMENT SYSTEM
22	Placement of LOCATOR Root Abutment
24	Cast-To Coping
26	MAINTENANCE OF THE LOCATOR ABUTMENT
26	Reline of Implant-Retained and Tissue Supported Overdentures
29	OVERDENTURE INSERTION, REMOVAL AND CLEANING GUIDELINES
29	For the Clinician and Patient
30	IMPORTANT INFORMATION ABOUT THE LOCATOR ATTACHMENT SYSTEM
32	RETURN POLICY AND WARRANTY

PLEASE NOTE: This document is designed to serve as a guide for dental clinicians using Zest Dental Solutions Products. It is not intended to be a substitute for professional training and experience. Please refer to the Instructions For Use for further information.

THE LOCATOR® COMPONENT REFERENCE LIST

LOCATOR ABUTMENTS/LASER BAR

IMPLANT ABUTMENTS

Implant Abutment
Multiple Implant Systems and
Tissue Cuff Heights



Multi-Unit Abutment
w/ Titanium Collar
08909



BAR ABUTMENTS

Bar Abutment Thread
08587 2.0m
08589 2-56



Cast-to Abutment
Stainless Steel
08586



ROOT ABUTMENTS

0° Root Abutment
Stainless Steel
08520



10° Root Abutment
Stainless Steel
08521



20° Root Abutment
Stainless Steel
08522



Cast-to Coping
Stainless Steel
08528



LASER BAR

Female Stainless Steel
08590-02
08590-10



Female Titanium
08588-02
08588-10



LAB PROCESSING

Impression Coping
08505



Abutment Analog
08530 4mm
08516 5mm



Abutment
w/Delrin Collar*
08917



Block-Out Spacer
08514



Processing Spacer
08569



Parallel Post
08517



Denture Cap Assembly
08510



Standard Range
Male Processing Pkg
08519



Extended Range
Male Processing Pkg
08540



Bar Male
Processing Pkg
8028



Black
Processing Male
08510

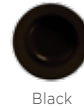

Yellow Bar
Processing Male
08026



Castable Threaded Insert
08013 2-56
08014 2.0mm



REPLACEMENT MALES

STANDARD RANGE

Extra Light
Retention Male
08529



Light
Retention Male
08527

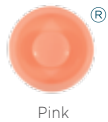

Regular
Retention Male
08524



Zero
Retention Male
08558



Extra Light
Retention Male
08548



Light
Retention Male
08915



Regular
Retention Male
08547



DRILLS & TAPS

Spot Face
Diamond Bur
08922



Pilot Drill
08924



Bar Drill
09102 1.7mm
(2.0mm Thread)
09103 1.8mm
(2-56 Thread)



Bar Tap
09104 2.0mm
09105 2-56



Drill & Tap
Holder
08016



Paralleling Mandrel
09107



Angle
Measurement Guide
09530



TORQUE DRIVERS & TOOLS

Torque Wrench Kit:
Torque Wrench, 15mm Square
Drive Insert and Thumb Knob
04391 20Ncm
9020 30Ncm



Square Drive Torque
Wrench Driver
08926 15mm
08927 21mm



Latch Type Torque
Wrench Driver
08913 23mm
08914 29mm



LOCATOR Core Tool:
Male Removal Tool, Male Seating Tool
& TiN Coated Abutment Driver
08393



*Used with Multi-Unit Abutment to fabricate LOCATOR Bar Attachment.

A RELIABLE RESTORATIVE SOLUTION THAT THE INDUSTRY, CLINICIAN COMMUNITY, AND PATIENTS HAVE COME TO TRUST.

For 40 years, Zest Dental Solutions (formerly ZEST Anchors) has been a global leader in the design, development, manufacturing and distribution of dental solutions for edentulous patients. The company pioneered pivoting, self-aligning attachments that substantially reduced the damage caused by the improper seating of overdentures.

Today, Zest's flagship product, LOCATOR, is recognized as an industry wide solution for implant-retained, tissue supported overdentures. The dental implant companies, that collectively make up more than 90% of the global implant market supply, partner with Zest to make the LOCATOR Abutment compatible with their dental implants.

The recognition does not stop there, LOCATOR's unique low profile design, pivoting technology, durability, and ease-of-use has propelled it to be the preferred choice of clinicians worldwide. Patient satisfaction is the ultimate goal, with more than two million patients enjoying an improved quality of life by trusting their clinician to secure their restoration with LOCATOR. It is clear that LOCATOR is the premiere choice for implant-retained, tissue supported overdentures.

Zest Dental Solutions is located in Carlsbad, California with global distribution through OEM implant companies, dealer/distributor networks, and a domestic retail sales operation.

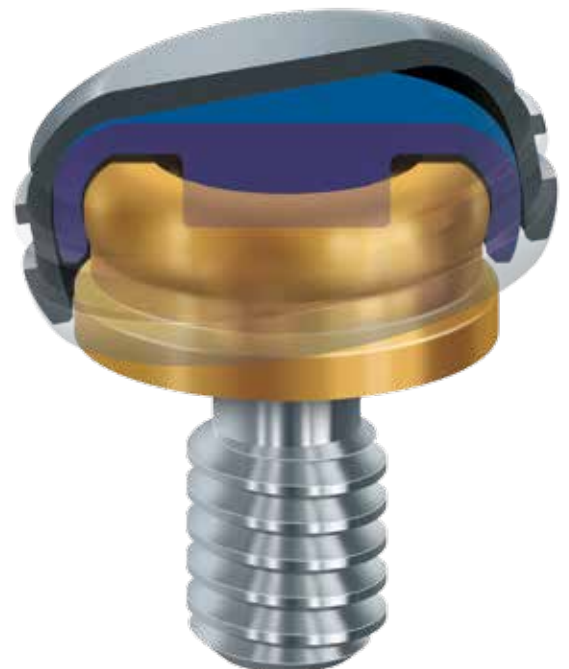

LOCATOR® - A FAMILY OF SOLUTIONS

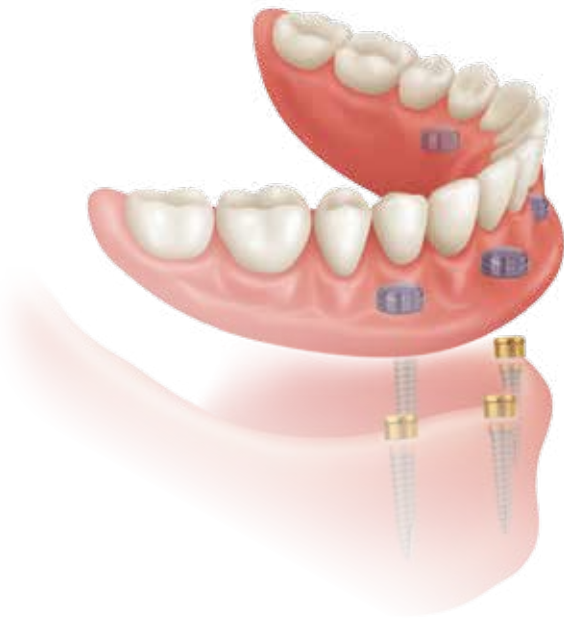

IMPLANT ATTACHMENT

The LOCATOR Implant Attachment with patented pivoting technology is the premier system for implant-retained overdentures. According to recent studies, a two implant-retained, tissue-supported overdenture restoration is considered the new minimum standard of care for edentulous patients. More than two implants may also be placed for an implant-retained overdenture.

BAR ATTACHMENT

When a case calls for an overdenture bar, the LOCATOR Bar Attachment provides the same pivoting technology, self-aligning feature, superb retention, and exceptional durability, all in a low-profile design. It also offers three options for the fabrication of a resilient attachment on an implant-supported cast alloy or milled titanium bar.



ROOT ATTACHMENT

In clinical situations where healthy tooth roots can be prepared for placement of attachments to retain an overdenture, the LOCATOR Root Attachment delivers great versatility. Its supra-radicular design gives you the choice of a straight post, 10° and 20° angles to accommodate divergent roots, as well as a special cast-to version.

LOCATOR® STANDARD AND EXTENDED RANGE MALES

THE MAGIC IS IN THE PIVOT, IT ALLOWS FOR A RESILIENT CONNECTION OF THE PROSTHESIS AND PREVENTS DAMAGE TO MALES DURING INSERTION.

STANDARD MALES

Dual retention to maximize stability and pivoting action that accommodates up to 20° divergence between two implants.

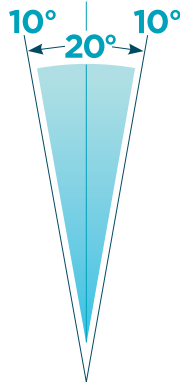

Extra Light Retention



Light Retention



Regular Retention

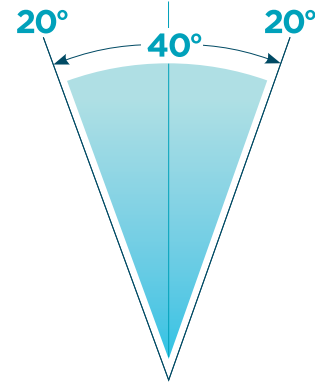

Zero Retention



Extra Light Retention



Light Retention



Regular Retention

LOCATOR® 3-IN-1 CORE TOOL

This convenient tool is used to carry the LOCATOR Abutment and place it onto the implant. It is also utilized for removal and seating the Males from/into the Denture Cap. In order to achieve 30Ncm of torque, the Abutment Driver portion of the tool is compatible with various types of restorative drivers.

REMOVAL TOOL

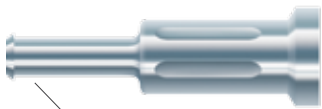

1

REMOVAL

The Removal Tool has a sharp edge on the end to engage and remove the Male from the Denture Cap.

SEATING TOOL



2

SEATING

The Seating Tool is used to seat the LOCATOR Male.

ABUTMENT DRIVER & SLEEVE



3

PLACEMENT

The Abutment Driver with the Abutment Holder Sleeve carries the Abutment securely and places it onto the implant.

USING THE CORE TOOL

Loosen the Removal end of the Core Tool a full 3 turns counter clockwise (you will see a visible gap).

REMOVING THE LOCATOR MALE FROM THE DENTURE CAP:

Insert the tip into the Denture Cap Assembly and push straight into the bottom of the Male. Tilt the tool so that the sharp edge of the tip will engage with the Male and pull it out of the Denture Cap.

DISENGAGING THE LOCATOR MALE FROM THE TIP OF THE CORE TOOL:

Point the tool down and away from you and tighten the Removal Tool clockwise back onto the Core Tool. This will activate the removal pin and disengage the Male from the tip of the Removal Tool.

PLACING THE LOCATOR MALE: Separate The Removal Tool section from the Core Tool and use the Seating Tool end to place a new Male into the empty Denture Cap.

NOTE THE GAP ONCE TURNED COUNTER CLOCKWISE

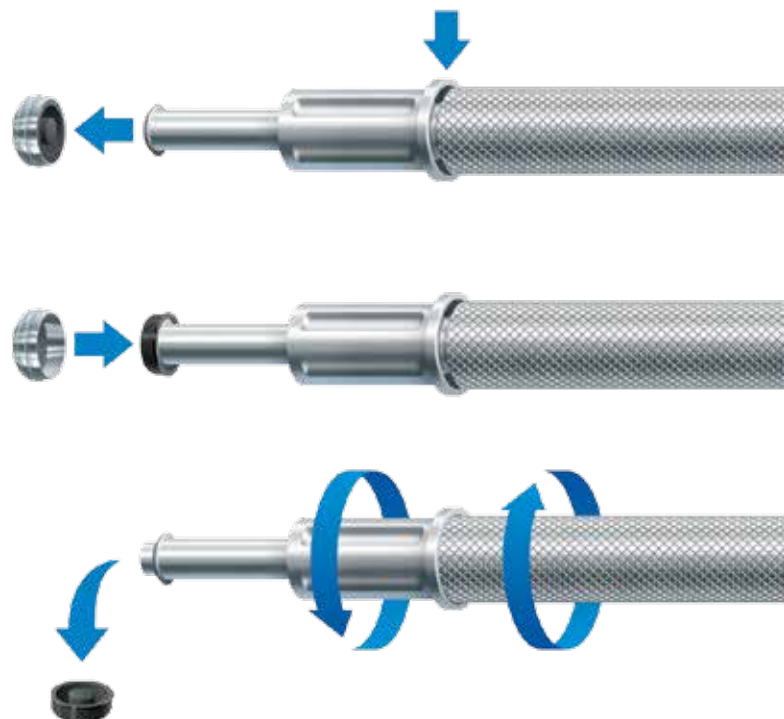

LOCATOR® IMPLANT ATTACHMENT SYSTEM

ABUTMENT AND REPLACEMENT MALE SELECTION

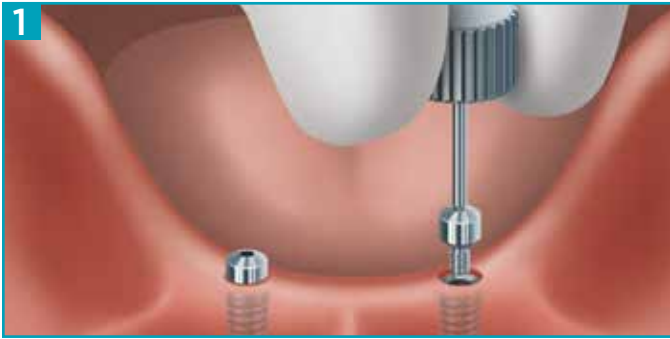

1 Identify the system and diameter of each implant. Remove the healing abutments.

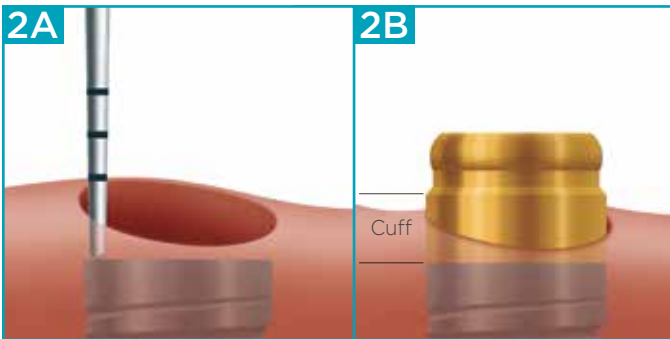

2A-2B Using a periodontal probe, measure the height of the gingiva at the highest point and select the cuff height of the LOCATOR Abutment that corresponds to that measurement. If it is 2mm, choose a 2mm cuff height. An additional 1.5mm of Abutment height will extend above the gingiva to accommodate for the Denture Cap.

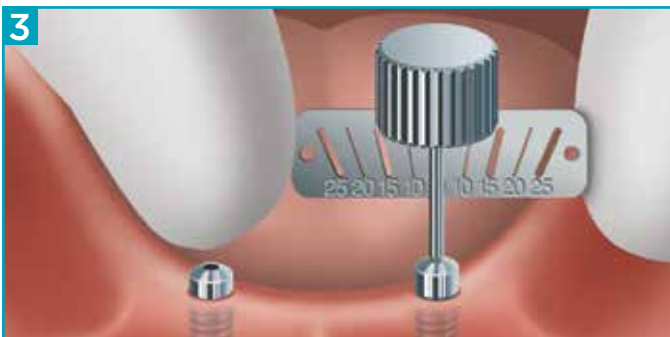

3 Use the Angle Measurement Guide to determine the angulation of each implant. Select the LOCATOR Standard Males for implants with 10° of divergence or less; and the LOCATOR Extended Range Males for implants with greater than 10° and less than 20° of divergence.

NOTE: Please refer to the Standard and Extended Range Male retention chart on page 4.

LOCATOR® IMPLANT ATTACHMENT SYSTEM

ABUTMENT PLACEMENT

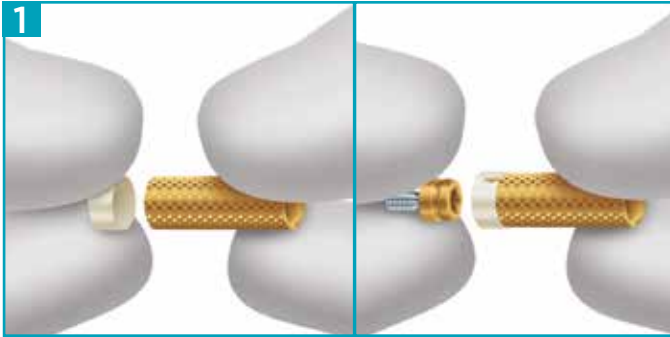

1 Slide the Abutment Holder Sleeve onto the abutment driver portion of the LOCATOR 3-in-1 Core Tool. Place the LOCATOR Abutment selected for each implant into the Abutment Holder Sleeve.



2 Screw the LOCATOR Abutment into the implant and hand tighten. Radiograph each interface to confirm that the Abutments are fully seated on the implants. Place the film perpendicular to the interface.



3 Using a torque device and the LOCATOR Driver Insert, torque each LOCATOR Abutment to 30Ncm or to the torque for an abutment screw recommended by the manufacturer of the implant/abutment system if that recommended torque is 35Ncm or less.

NOTE: Implants with $\leq 1.4\text{mm}$ thread require the LOCATOR Abutment be torqued to 20Ncm.

WARNING: Use of higher torque values than recommended could cause a fracture of the LOCATOR Abutment.

A direct or indirect technique may be used for processing the Denture Cap into the overdenture. Please refer to page 8 for Direct Technique and page 11 for Indirect Technique for the LOCATOR Implant Attachment System.

PROCESSING LOCATOR® DENTURE CAPS INTO THE OVERDENTURE, DIRECT TECHNIQUE

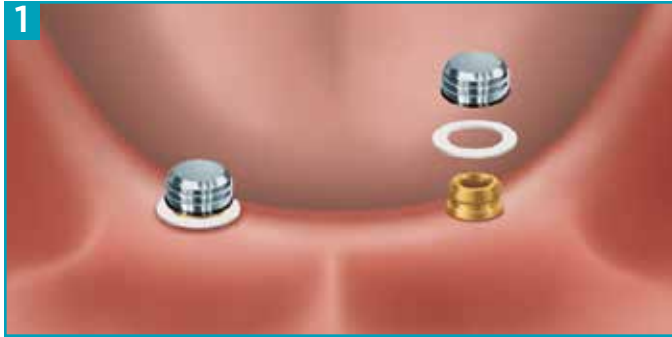

DIRECT TECHNIQUE FOR NEW OR EXISTING DENTURE

1 Place a White Block-Out Spacer around each Abutment and press it down to the tissue. Snap a Denture Cap with a pre-loaded Black Processing Male onto each Abutment, pressing down firmly.

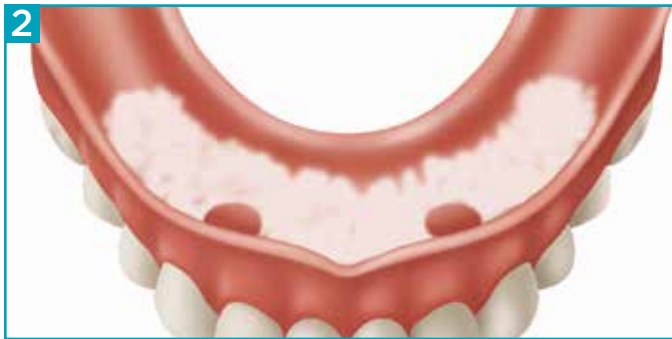

2 Apply fit check marking paste to the intaglio surface of the overdenture. Insert it into the mouth in position over the Denture Cap. This will mark areas where the overdenture will need to be relieved to allow space for the Caps to be picked up.

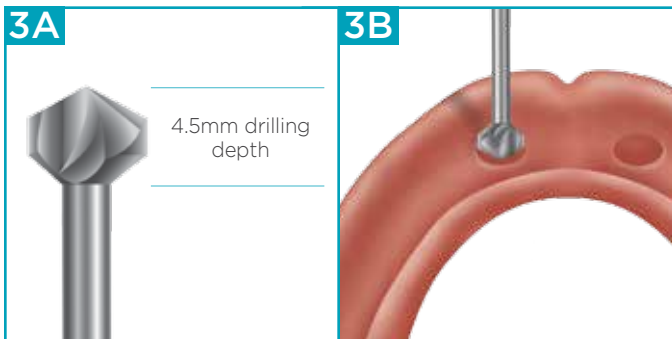

3A-3B Relieve the marked areas with the CHAIRSIDE® Recess Bur. Zest recommends using slight pressure and a small rocking motion to get the tip of the Bur started, followed by a straight downward motion to create the desired recess site. This efficient Bur has distinct depth landmarks which indicate where to stop when drilling for the Denture Cap.

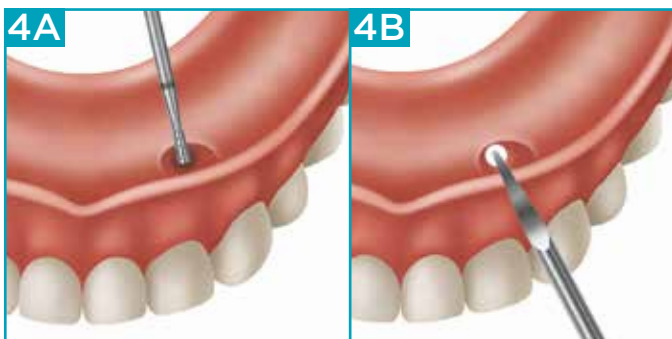

4A-4B Use the CHAIRSIDE Undercut Bur to cut an undercut around the circumference of the recesses for mechanical retention. Cut lingual/palatal vent windows in the overdenture with the CHAIRSIDE Vent Bur to visualize full seating and for excess material to vent.

PROCESSING LOCATOR® DENTURE CAPS INTO THE OVERDENTURE, DIRECT TECHNIQUE (CONTINUED)



5 Dry the Denture Caps. Apply a small amount of CHAIRSIDE® Attachment Processing Material around the circumference of each cap. Place CHAIRSIDE Material into the recesses in the overdenture and seat it over the Housings and onto the tissue. Have the patient close into light occlusion and hold while the CHAIRSIDE Material sets. Please refer to CHAIRSIDE Attachment Processing Material IFU for set times.

NOTE: Excessive occlusal pressure during the setting time may cause tissue recoil against the overdenture base and could contribute to dislodging and premature wear of the Males.



6 Disengage the overdenture from the Abutments and remove from the mouth. Verify that the Denture Caps have been securely processed into the overdenture. Fill any voids and light cure. The material will bond to itself and will cure within 30 seconds with light application. Remove any excess material with the CHAIRSIDE Grind Bur.



7 Use the CHAIRSIDE Trim Bur to remove any excess acrylic material remaining on the overdenture.



8 Use the CHAIRSIDE Polish Bur to create a smooth finish of the overdenture.

PROCESSING LOCATOR® DENTURE CAPS INTO THE OVERDENTURE, DIRECT TECHNIQUE (CONTINUED)

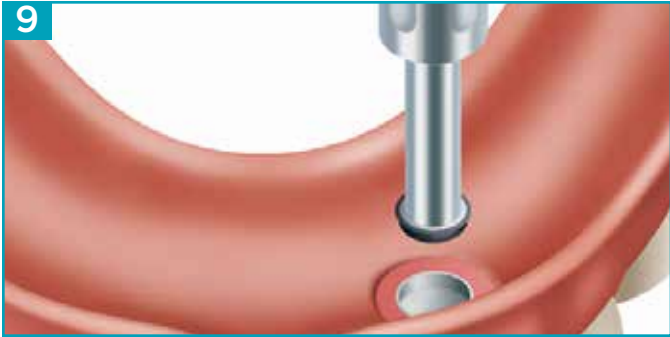

9 Remove the Black Processing Male using the Removal Tool.

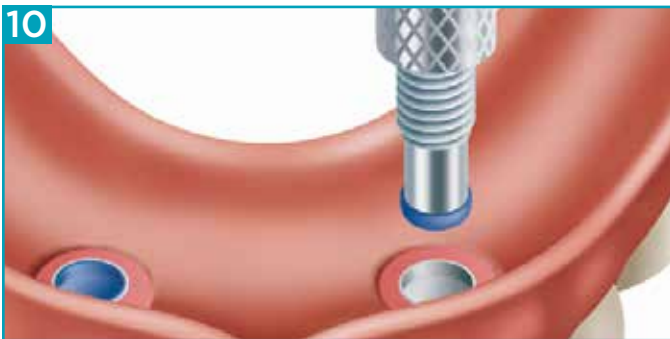

10 Place the selected final Male into each Denture Cap using the Seating Tool. Start with the least retentive Male for the initial patient try-in. Please refer to LOCATOR 3-In-1 Core Tool instructions on page 5.



11 Seat the overdenture and press down to engage the Males on the LOCATOR Abutments and verify the occlusion. Instruct the patient on how to remove and insert the overdenture. If the retention is not satisfactory, remove the Males and replace with the next level of retention. Refer to the Standard and Extended Range Male retention chart on page 4. Please refer to page 29 for instructions on proper home care maintenance and required recall visits.

PROCESSING LOCATOR® DENTURE CAPS INTO THE OVERDENTURE, INDIRECT TECHNIQUE



INDIRECT TECHNIQUE/LABORATORY PROCESSING

1 A stock or custom impression tray may be used. Ensure that each recess has enough space for the height of the LOCATOR Impression Copings.



2 Place a LOCATOR Impression Coping on each Abutment and press down firmly. Syringe CHAIRSIDE® Medium Body Impression Material, around the circumference of each coping. Fill the impression tray and insert it over the copings and onto the tissue. Allow the material to set and remove the Impression Tray.

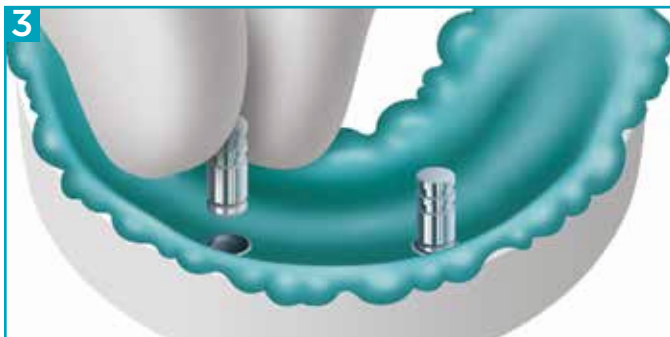

3 Seat the appropriate diameter LOCATOR Analogs into each Impression Coping and send the impression to the laboratory.



4 Verify that the analogs are secure in the impression copings and pour a model.

PROCESSING LOCATOR® DENTURE CAPS INTO THE OVERDENTURE, INDIRECT TECHNIQUE (CONTINUED)

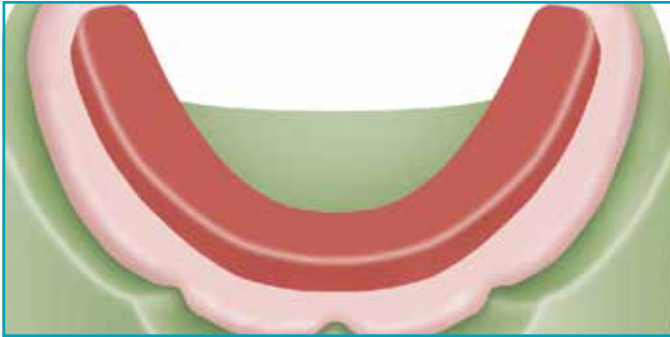

5 Fabricate the baseplate and wax rim on the cast for the bite registration. The Denture Caps with Black Processing Males may be processed into the baseplate to provide stabilization during record making and try-in.

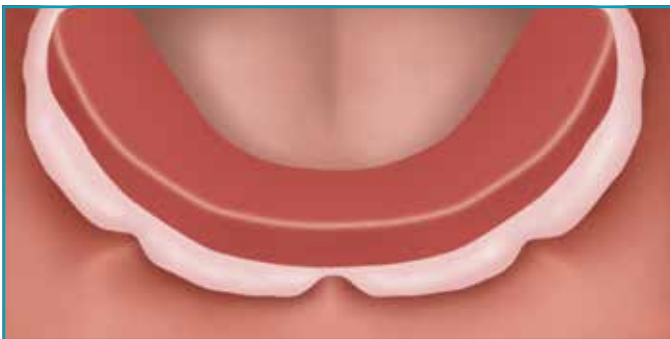

6 BITE RECORDS

Place the bite block into the mouth and record the jaw relation. Take an impression of the opposing arch and pour the cast. Select a shade for the overdenture teeth.



7 Articulate the models and proceed with the overdenture teeth set up.



8 OVERDENTURE TRY-IN

Place the try-in overdenture into the mouth and verify the fit, attachment engagement, esthetics, phonetics and occlusion.

PROCESSING LOCATOR® DENTURE CAPS INTO THE OVERDENTURE, INDIRECT TECHNIQUE (CONTINUED)



9 Finalize and flask the overdenture for processing. Separate the flask and boil away all wax. Place the Denture Caps with Black Processing Males on the Analogs and press down firmly. Place the cast back into the flask and verify that there is no contact with the teeth. Close the flask and process the overdenture. Remove the overdenture from the flask, finish, and polish.



10 Optional Step: A Processing Spacer could be used instead of the Denture Caps during the fabrication of the overdenture if the clinician prefers to pick up the Denture Caps chairside. The Processing Spacer creates a recess in the overdenture to allow for the Denture Cap to be seated without any interference with the surrounding overdenture acrylic.

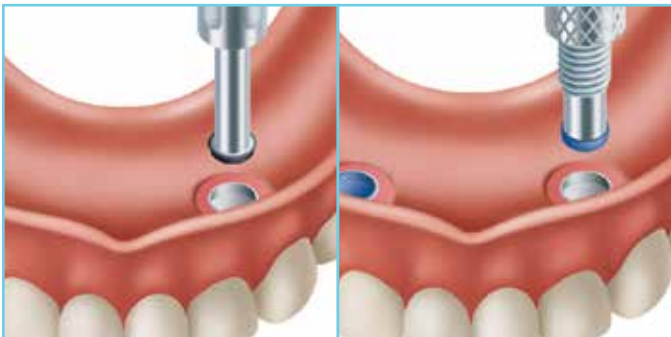

11A-11B Remove the Black Processing Male using the Removal Tool. Place the selected final Male into each Denture Cap using the Seating Tool. Start with the least retentive Male for the initial patient try-in.

NOTE: Please refer to the LOCATOR 3-In-1 Core Tool instructions on page 5.



12 DELIVERY

Place the overdenture in the mouth and press down to engage the Males on the Abutments. Verify the occlusion. If the retention is not satisfactory, remove the Males and replace with the next level of retention.

NOTE: Please refer to the Standard and Extended Range Male chart on page 4 for additional selection criteria. Please refer to page 29 for instructions on proper home care maintenance and required recall visits.

LOCATOR® BAR ATTACHMENT SYSTEM

DRILL AND TAP

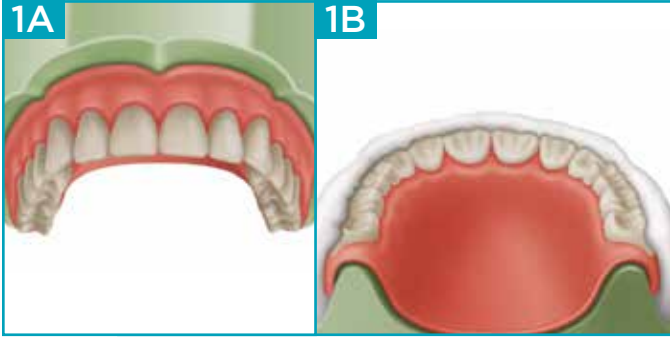

1A-1B After completing the overdenture wax try-in, make a matrix of the set up.

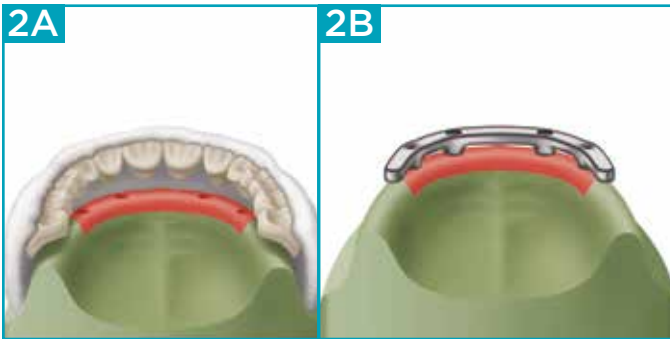

2A-2B With the teeth placed back in the matrix, seat the matrix on the model. Determine the locations for the LOCATOR Bar Abutments in relation to the implant positions, spacing between Abutments, and the interarch space.

Fabricate the bar.

NOTE: A minimum of 5.0mm between the edges of multiple LOCATOR Bar Abutments is required to avoid interference with the Denture Caps.



3 Using a round bur, create a dimple in the top of the bar at the Abutment locations elected.

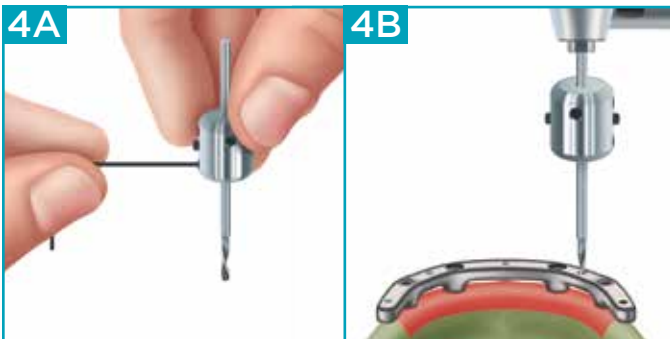

4A-4B Select the appropriate Bar Drill and finger tighten into the Drill and Tap Holder. Place the assembly into the handpiece. Position the drill on the dimple and drill to a depth of 2.8mm.

LOCATOR® BAR ATTACHMENT SYSTEM

DRILL AND TAP (CONTINUED)

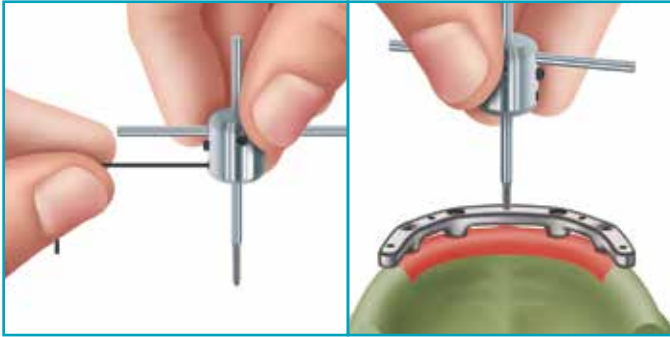

5A-5B Select the appropriate Bar Tap and finger tighten into the Drill and Tap Holder. Manually tap the threads within each drilled site.

NOTE: The use of tapping fluid while cutting the threads into the bar is required to reduce the chance of breaking the tap off in the site.

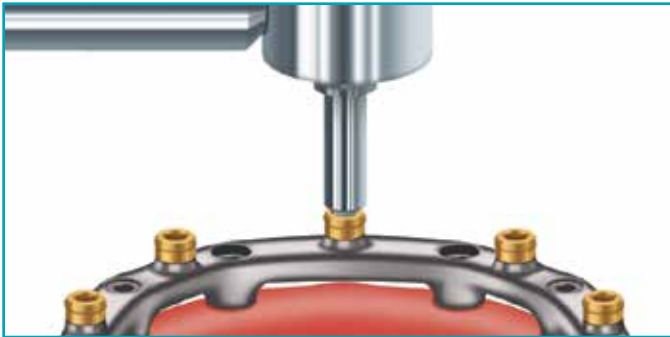

6 Seat each LOCATOR Bar Abutment to 30Ncm using a torque device and the LOCATOR Driver Insert.



7 Snap a Denture Cap with a yellow Processing Male onto each LOCATOR Abutment and verify that the bar does not interfere with the seating of the Denture Cap. Proceed with the fabrication of the prosthesis.

LOCATOR® BAR ATTACHMENT SYSTEM

CASTABLE THREADED INSERT

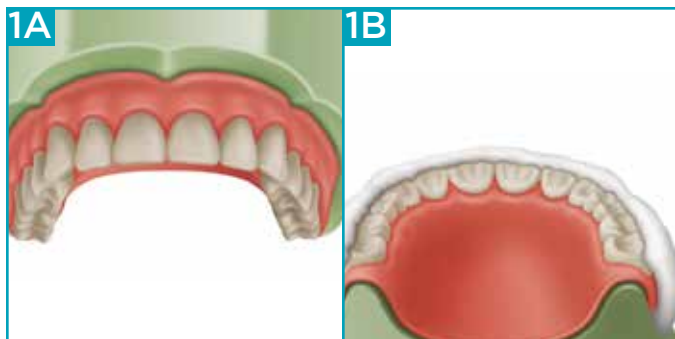

1A-1B After completing the overdenture wax try-in, make a matrix of the teeth set up.

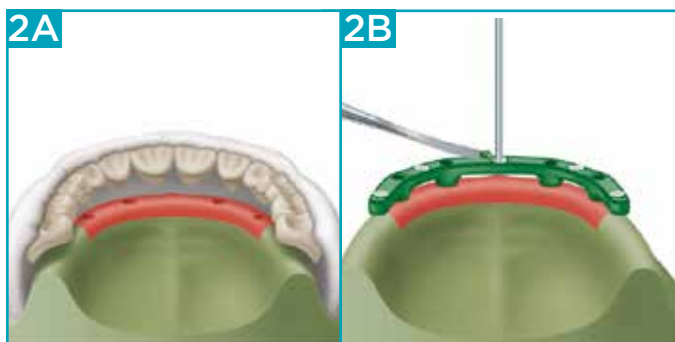

2A-2B With the teeth placed back in the matrix, seat the overdenture bar onto the implant components. Survey and set a Castable Threaded Insert into the wax pattern of the bar at the locations selected.

NOTE: A minimum of 5.0mm between the edges of multiple LOCATOR Bar Abutments is required to avoid interference with the Denture Caps.



3 Invest and cast the bar using standard casting procedures. The threaded inserts will become part of the cast bar.

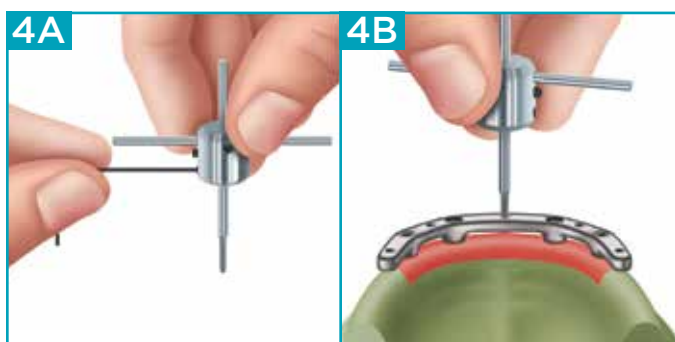

4A-4B Divest, finish and polish the cast bar. Finger tighten the Bar Tap manually into the Drill and Tap Holder. Use the Bar Tap to manually chase and clean the internal threads of each insert.

NOTE: The use of tapping fluid while cleaning the threads into the bar is required to reduce the chance of breaking the tap off in the site.

LOCATOR® BAR ATTACHMENT SYSTEM

CASTABLE THREADED INSERT (CONTINUED)

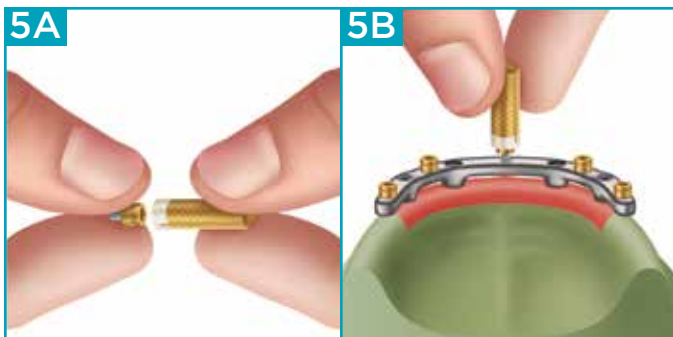

5A-5B Place the LOCATOR Abutment into the Abutment Holder Sleeve and thread the Abutment into each castable insert.

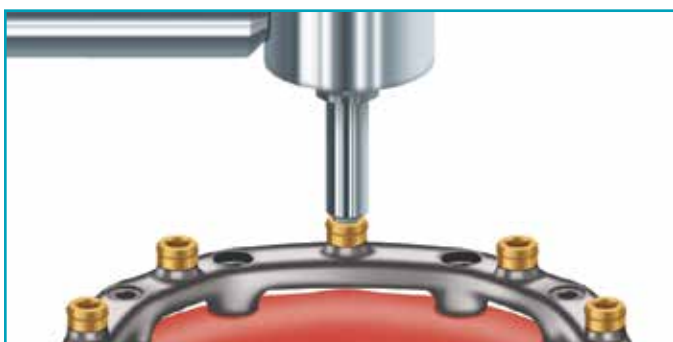

6 Torque each LOCATOR Bar Abutment to 30Ncm using a torque device and the LOCATOR Driver Insert.



7 Snap a Denture Cap with a yellow Processing Male onto each LOCATOR Abutment and verify that the bar does not interfere with seating of the Denture Cap. Proceed with the fabrication of the prosthesis.

LOCATOR® BAR ATTACHMENT SYSTEM

LASER WELD

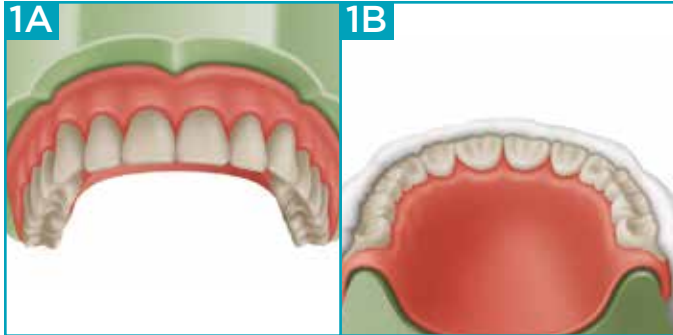

1A-1B After completing the overdenture wax try-in, make a matrix of the teeth set up.

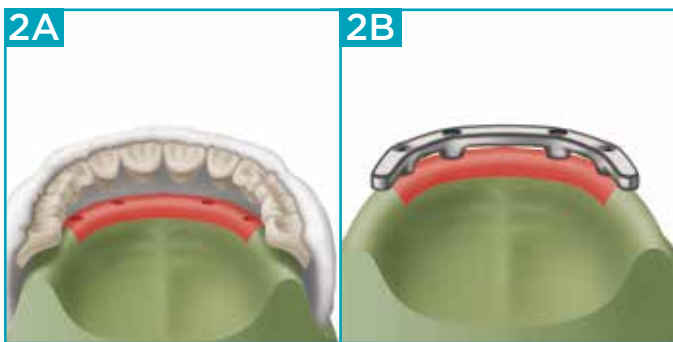

2A-2B With the teeth placed back in the matrix, seat the matrix on the model. Determine the locations for the LOCATOR Bar Abutments in relation to the implant positions, spacing between attachments and the interarch distance space.

Fabricate the bar.

NOTE: A minimum of 5.0mm between the edges of multiple LOCATOR Bar Abutments is required to avoid interference with the Denture Caps.



3 Place the matrix back on the model over the bar and verify that there is the needed space for the attachment at each location.

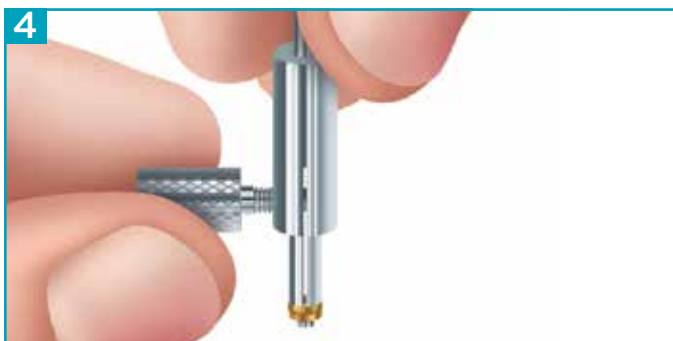

4 Place the split end of the LOCATOR Paralleling Mandrel into the socket of the Laser Bar and finger tighten the knurled set screw to spread the split portion and secure the Abutment on the mandrel.

LOCATOR® BAR ATTACHMENT SYSTEM

LASER WELD (CONTINUED)

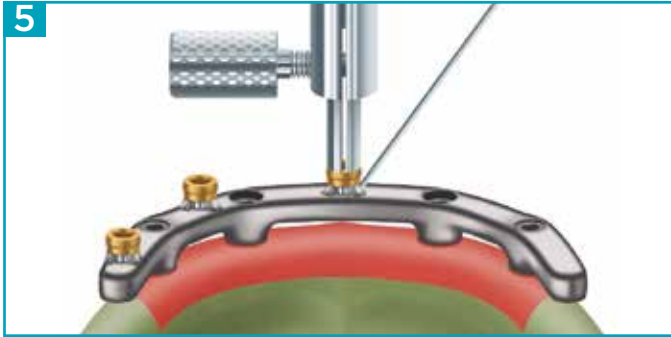

5 Place the Paralleling Mandrel in a surveyor and place the LOCATOR Bar Abutments in position on the bar. Tack the LOCATOR Bar Abutments into place by spot welding on opposite sides.

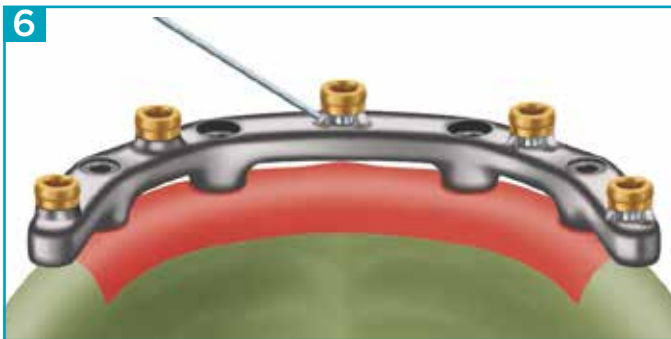

6 Loosen the screw on the Paralleling Mandrel and remove it. Form a bead of weld around the entire circumference of the base area, welding the LOCATOR Bar Abutments to the bar.

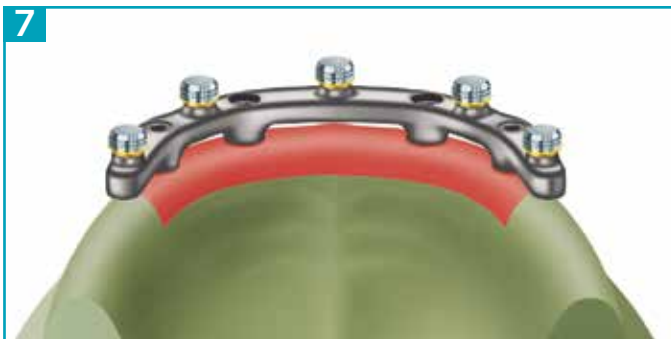

7 Snap a Denture Cap with a Yellow Processing Male onto each LOCATOR Bar Abutment and verify that the laser weld does not interfere with the Housing seating completely.

Proceed with the fabrication of the prosthesis.

LOCATOR® BAR ATTACHMENT SYSTEM

CAST-TO BAR

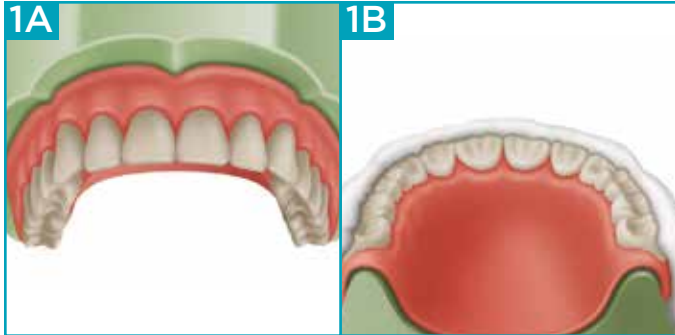

1A-1B After completing the overdenture wax try-in, make a matrix of the teeth set up.

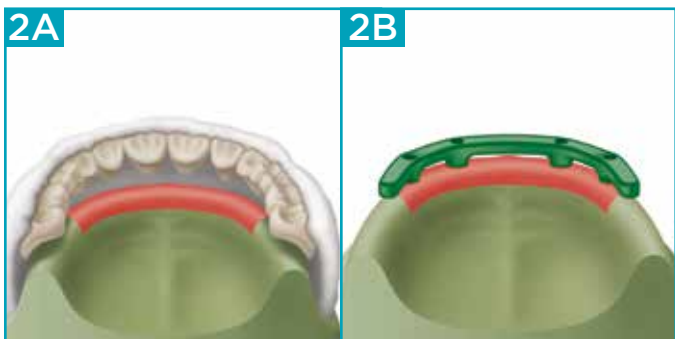

2A-2B With the teeth placed back in the matrix, seat the matrix on the model. Determine the locations for the LOCATOR Bar Abutments in relation to the implant positions, spacing between attachments and the interarch space. Wax the overdenture bar to the implant components.

A minimum of 5.0mm between the edges of multiple LOCATOR Bar Abutments is required to avoid interference with the Denture Caps.



3 Place the split end of the LOCATOR Paralleling Mandrel into the socket of the Laser Bar Abutments and finger tighten the knurled set screw to spread the split portion and secure the Abutments on the mandrel.



4 Use the LOCATOR Paralleling Mandrel in a surveyor to place all the Cast-To Bar Abutments into the waxed bar ensuring parallelism. Wax the Cast-To Bar Abutments into position.

LOCATOR® BAR ATTACHMENT SYSTEM

CAST-TO BAR (CONTINUED)

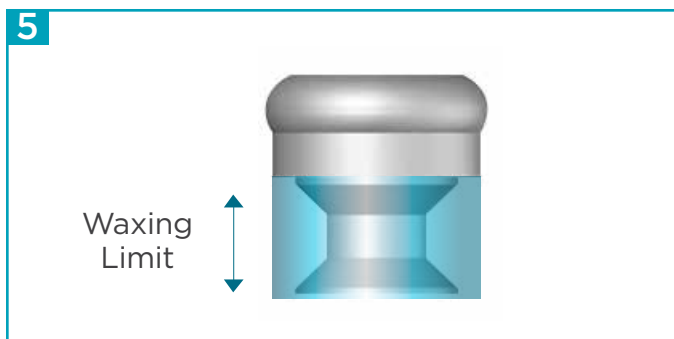

5 Wax should be built up to the top of the retentive recess and not above the line indicated.



6 Invest and cast the Bar using standard casting procedures. The Cast-To Bar Abutments will become part of the cast bar.

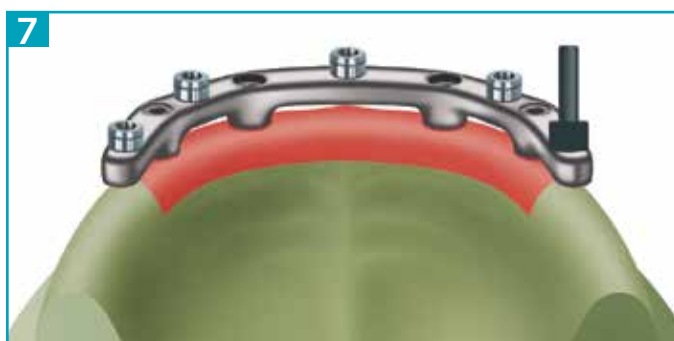

7 Divest, finish and polish the cast bar. Use caution to not damage the Cast-To Abutments. A LOCATOR Parallel Post may be placed on the Abutment to protect it while polishing.



8 Snap a Denture Cap with a Yellow Processing Male onto each LOCATOR Abutment and verify that there are no interferences with the bar.

Proceed with the fabrication of the prosthesis.

LOCATOR® ROOT ATTACHMENT SYSTEM

PLACEMENT OF LOCATOR ROOT ABUTMENT

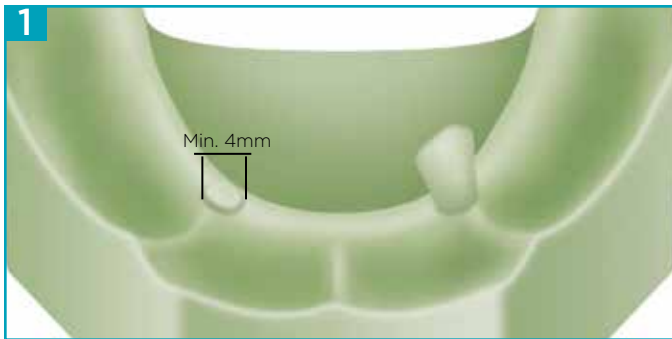

1 Take an impression of the arch and pour a diagnostic model. Reduce the teeth to 1mm above the gingival tissue and measure the root width to determine the space available for a LOCATOR Root Abutment.

NOTE: The width of the root surface must equal or exceed 4mm.

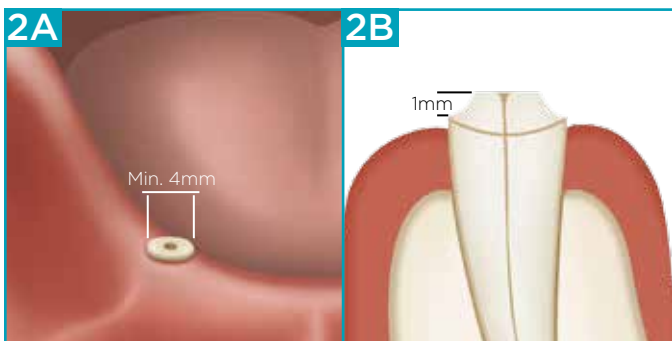

2A-2B Radiograph the tooth roots to measure and determine the proper angle of post on the LOCATOR Abutment. Decoronate the root and perform endodontic therapy. Remove the desired depth of gutta percha following standard clinical procedures. Finish contouring of the roots. The final reduction should place the root surface 1mm supragingival.

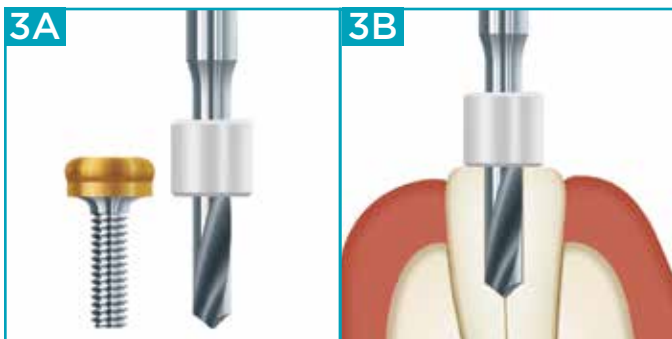

3A-3B Hold the LOCATOR Abutment next to the Pilot Drill and set the plastic Depth Reference Ring on the Pilot Drill to match the screw threads length. The screw threads can be shortened if needed. Size the canal using the Pilot Drill stopping at the depth ring. The alignment of this initial preparation will generally follow the canal. On a non-parallel root, the resulting divergence can be corrected using an angled LOCATOR Abutment 10° or 20°.

CAUTION: The danger of root perforation exists when the full length of the Pilot Drill is used.

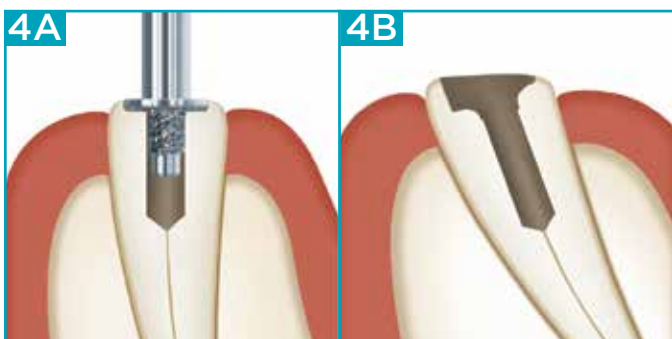

4A-4B Spotface the root surface using the Spotface Diamond Bur to a depth where a full 360° recessed seat first appears on the occlusal surface of the root. When making a countersink preparation into a divergent root, the depth of the countersink will vary across the surface. Create the minimum possible recessed seat on the shallow side of the preparation.

In the event a portion of the original depth from the Pilot Drill canal preparation is lost due to countersinking, re-establish the full depth of the canal preparation with the Pilot Drill using the original Depth Reference Ring Setting.

LOCATOR® ROOT ATTACHMENT SYSTEM

PLACEMENT OF LOCATOR ROOT ABUTMENT (CONTINUED)

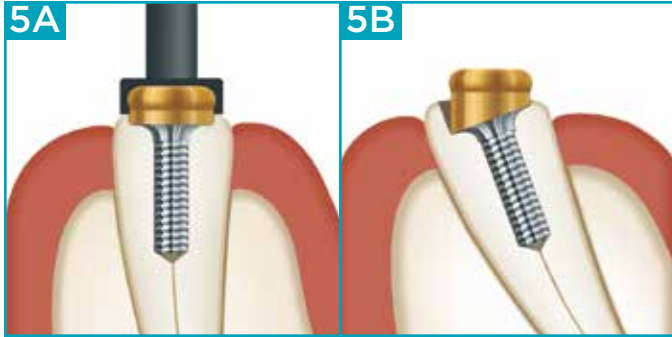

5A-5B Place a LOCATOR Parallel Post onto a 0° LOCATOR Root Abutment to act as handle. Place a 0° LOCATOR Root Abutment into each of the prepared roots and verify the proper fit and parallel alignment of multiple Abutments. If the alignment of any of the Abutments can be improved for draw, select the most suitable angled LOCATOR Root Abutment (10° or 20°) and try it into the preparation to determine ideal parallelism.

NOTE: Make a small indexing mark on the LOCATOR Root Abutment base and the root surface to return the angled Root LOCATOR to the exact position during cementation.

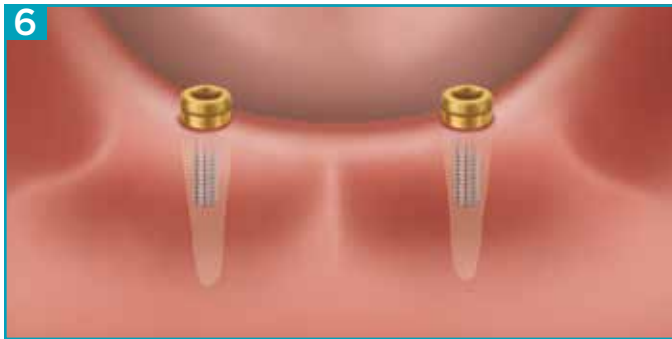

6 Cement the LOCATOR Root Abutment in place with dental cement of choice. Allow the cement to set. Round off and polish the root surface from the metal flange to the tissue. The Parallel Post can be placed on the LOCATOR Root Abutment to protect it during polishing.

Please refer to page 8 for Direct Pick-Up Techniques.

LOCATOR® ROOT ATTACHMENT SYSTEM

CAST-TO COPING

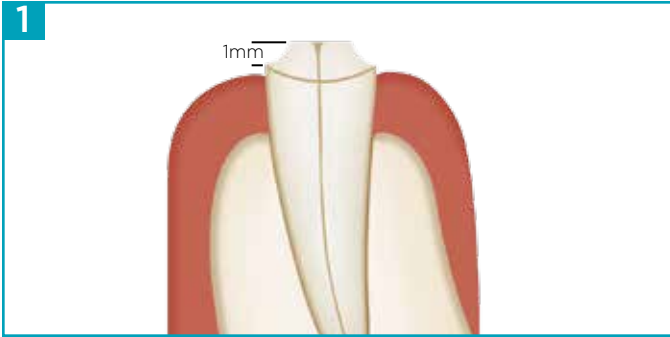

1 CAST-TO COPING

Decoronate the root and perform endodontic therapy. Remove the desired depth of gutta percha following standard clinical procedures. Finish the contouring of the root. The final reduction should place the root surface 1mm above gingival tissue. Prepare with a beveled shoulder or a chamfer margin.



2 Hold the Cast-To LOCATOR Abutment next to the Pilot Drill and set the plastic Depth Reference Ring on the Pilot Drill to a depth that slightly exceeds the Cast-To Coping thread length.



3 Size the canal using the Pilot Drill stopping at the depth ring. The alignment of this initial preparation will generally follow the canal. On a non-parallel root, the resulting divergence can be corrected using an angled LOCATOR Root Abutment (10° or 20°).

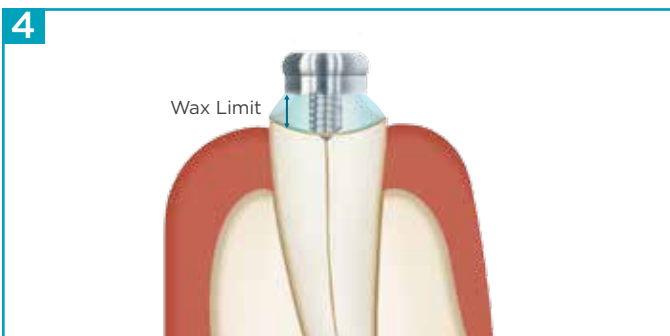

4 Complete the preparation of the site with dental burs of preference to ensure that the cast gold coping will completely surround the LOCATOR Cast-To Abutment.

NOTE: The outer surface on the base of the LOCATOR Cast-To Abutment must remain above the level of the coping to allow the Denture Cap to snap on without interference.

Please refer to page 8 for Direct Pick-Up Techniques.

LOCATOR® ROOT ATTACHMENT SYSTEM

CAST-TO COPING (CONTINUED)



5 Take an impression of the arch and of the prepared roots, capturing as much detail as possible. Pour the master cast and prepare the dies.



6 Using a surveyor, place the Parallel Post with the Cast-To LOCATOR Root Abutment attached in position and parallel with other Abutments. Wax the Cast-To LOCATOR Root Abutment directly into the die. Build the wax up to the bottom corner on the base of the Abutment, leaving the majority of the outer surface on the base above the level of the coping. Remove the wax up from the die and remove the Parallel Post from the Abutment, leaving the top of the Abutment open for investment material to flow into.

Invest and cast. Finish and polish the surface of the coping. The Parallel Post can be placed on the LOCATOR to protect it while polishing.



7 Snap a Denture Cap with a Black Processing Male onto each LOCATOR Analog and verify that there is no interference with the Denture Cap seating.

Proceed with the fabrication of the prosthesis.

Please refer to page 8 for Direct Pick-Up Techniques.

MAINTENANCE OF THE LOCATOR® ABUTMENT

RELINE OF IMPLANT-RETAINED AND TISSUE SUPPORTED OVERDENTURES



1 Remove the Males from the overdenture.

NOTE: Please refer to the LOCATOR Core Tool instruction on page 5.



2 Using a trephine drill, remove the existing Denture Cap from the overdenture.

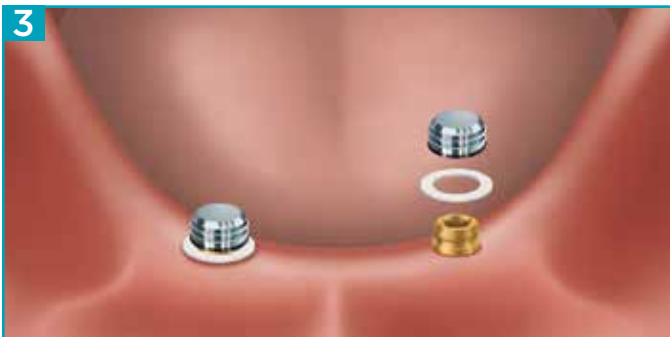

3 Place a white Block-Out Spacer around each Abutment and press it down to the tissue. Snap a new Denture Cap with a pre-loaded Black Processing Male onto each Abutment, pressing down firmly. Try in the overdenture to ensure each recess is large enough to accommodate the new Denture Cap with no interference with the acrylic.

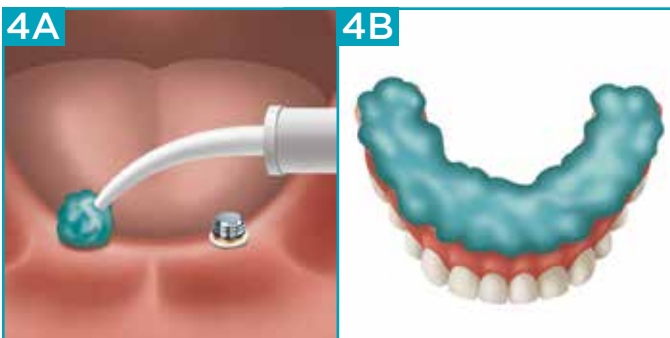

4A-4B Apply an adhesive to the intaglio surface of the overdenture and take an impression using the overdenture as a tray. Place the overdenture into the mouth. Have the patient close into the light occlusion and hold. Allow the impression material to set.

MAINTENANCE OF THE LOCATOR® ABUTMENT

RELINE OF IMPLANT-RETAINED AND TISSUE SUPPORTED OVERDENTURES (CONTINUED)

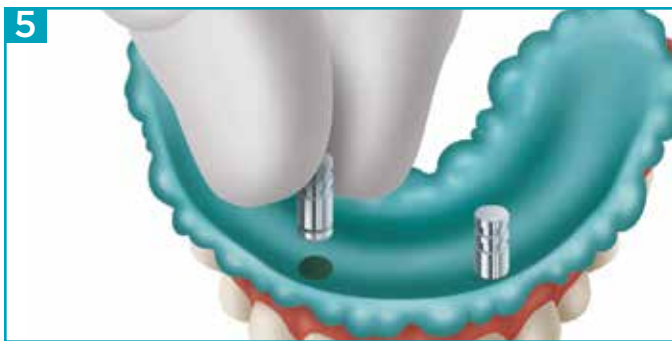

5 Remove the overdenture from the mouth. The Denture Cap will be picked up in the impression. Press the LOCATOR Analogs into the Black Processing Males. Send the reline impression to the laboratory.



6 Verify that the Analogs are secure in the Black Processing Males and pour a master cast.



7 Mount the cast with the overdenture on it in a reline jig.



8 Separate the reline jig and remove the impression material from the overdenture. Process the reline and remove the overdenture from the reline jig. Finish and polish.

MAINTENANCE OF THE LOCATOR® ABUTMENT

RELINE OF IMPLANT-RETAINED AND TISSUE SUPPORTED OVERDENTURES (CONTINUED)

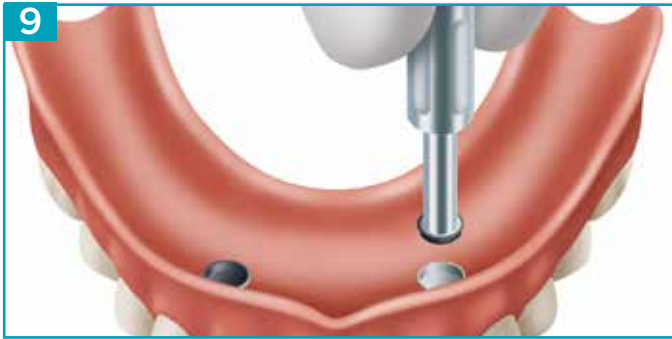

9 Remove the Black Processing Male using the LOCATOR Core Tool.



10 Place the selected final Male into each Denture Cap using the Seating Tool. Start with the least retentive Male during the initial patient try-in.



11 DELIVERY

Place the overdenture in the mouth and press down to engage the Males on the Abutments. Verify the occlusion. If the retention is not satisfactory, remove the Males and replace with the next level of retention.

NOTE: Please refer to the LOCATOR 3-In-1 Core Tool instructions on page 5.

NOTE: Please refer to page 29 for instructions on proper home care maintenance and required recall visits.

OVERDENTURE INSERTION, REMOVAL AND CLEANING GUIDELINES FOR THE CLINICIAN AND PATIENT

To reduce wear on LOCATOR® Abutments, it is critical that clinicians and patients perform routine maintenance on both the LOCATOR Abutment, the Denture Cap and the Male. It is also important that patients understand the proper overdenture maintenance that should be performed at home to guard against retention loss of the Male within the Denture Cap. The following are guidelines to consider:

INSERTING AND REMOVING AN OVERDENTURE

To insert the overdenture, the patient should ensure he/she can feel that it is properly positioned above the LOCATOR Abutments prior to applying pressure. The patient should use both hands and simultaneously press down on each side to firmly seat the overdenture into place.

The patient should avoid biting the overdenture into place as this force will result in improper wear of the LOCATOR Abutment and may affect the longevity of the prosthesis.

The patient should remove the overdenture by placing one finger under the left edge and one under the right edge of the overdenture and pull one side upward at a time. Once the overdenture is removed a thorough cleaning is recommended.

CLEANING AN OVERDENTURE

Maintaining proper hygiene is vital to the success of an overdenture, helping it last longer and function properly. Similar to natural teeth, dental plaque will also form on the surface of an overdenture. If the plaque is not removed it will continue to accumulate. It is for this reason that the overdenture should be taken out for cleaning daily. Patients should follow these two simple steps daily for cleaning an overdenture.

1 Fill a washing basin with warm water to prevent fracture of the overdenture. Apply non-abrasive toothpaste onto a soft bristle toothbrush and thoroughly clean every surface of the overdenture.

2 Each night, remove Overdenture and immerse in a cup of plain water.

ADDITIONAL NOTES OF CAUTION

Failure of the patient to follow oral hygiene protocols and appropriately care for the overdenture may also result in inflamed tissue around the implant, leading to the development of peri-implantitis. Throughout time, peri-implantitis may cause the implant to become mobile and fail. Please ask patients to consider the following when caring for their overdentures:

- Avoid using abrasive toothpaste to clean the overdenture. The coarse particles in the toothpaste may scratch the surfaces of the overdenture, enhancing the potential for plaque accumulation.
- Chewing tobacco may get caught in the Males and scratch the Abutments, considerably reducing the life of the Abutments, retentive features of the Males and ultimately may affect the dental implants.
- Do not soak the overdenture in bleach or any other products not designed for use with denture cleaning as these can harm the retentive feature of the Male, which may ultimately cause additional wear on the Abutment.
- If a denture cleaning solution such as Polident® and Efferdent® must be used, it is recommended that the overdenture be soaked for fifteen minutes or less.
- Instruct patients to brush LOCATOR Abutments with a soft-bristled toothbrush and visit the dentist for regular inspection and maintenance of the Abutments, Males and Denture Caps.
- Refrain from picking at the Abutments with toothpicks or other foreign objects.
- Refrain from eating without the overdenture in place as food will scratch the Abutment and may result in failure of the dental implant.
- Oral rinse such as Listerine® mouthwash can be used safely without any negative effect on the Abutments or Replacement Males.
- Do not wash the overdenture in the dishwasher.

IMPORTANT INFORMATION ABOUT THE LOCATOR® ATTACHMENT SYSTEM

LOCATOR Implant Attachment System, Bar Attachment System, Root Attachment System (including Retrofit for ERA Root Attachment), and Attachment Systems for Multi-Unit Abutments

Includes:

Specific LOCATOR Attachments (i.e. Abutments, Bar and Root Females, etc.), Replacement Males, Denture Cap, Ancillary Processing Parts (i.e. analogs, processing spacer, block out spacer, parallel post, castable threaded insert, etc.), and Tools.

IMPORTANT:

Please read and retain. Please refer to the Zest Dental Solutions website for the latest version of this document, www.zestdent.com

DESCRIPTION

Implant Attachment:

Universal hinge, resilient attachment for endosseous implants in the mandible or maxilla in order to restore masticatory function. The attachment system allows for the prosthesis to be removed and replaced by the patient.

Bar Attachment:

Universal hinge, resilient attachment for bar splinted endosseous implants.

Attachments for Multi-Unit Abutments:

Universal hinge, resilient attachment for connection to both angled and straight Multi-Unit Abutments

Root Attachment:

Universal hinge, resilient attachment for endodontically treated roots.

Retrofit for ERA Root Attachment:

Universal hinge, resilient attachment converts worn or damaged standard sized ERA attachments to new LOCATOR attachments for endodontically treated roots.

INDICATIONS

Implant Attachment:

The LOCATOR Implant Attachment System is designed for use with overdentures or partial dentures, retained in whole or in part, by endosseous implants in the mandible or maxilla.

Bar Attachment:

The LOCATOR Bar Attachment System is designed for use with overdentures or partial dentures, retained in whole or in part, by bar splinted endosseous implants in the mandible or maxilla.

Implant Attachment for Multi-Unit Abutments:

The LOCATOR Implant Attachment System is designed for use as a free-standing resilient attachment connection with angled or straight Multi-Unit Abutments in the mandible or maxilla for retaining overdentures.

Bar Attachment for Multi-Unit Abutments:

The LOCATOR Bar Attachment System is designed for use as a splinted bar attachment connector with angled or straight Multi-Unit Abutments in the mandible or maxilla for retaining overdentures.

Root Attachment (including Retrofit for ERA Root Attachment):

The LOCATOR Root Attachment System is designed for use with overdentures or partial dentures, retained in whole or in part, by endodontically treated roots in the mandible or maxilla.

CONTRAINDICATIONS

Implant Attachment:

Not appropriate where a totally rigid connection is required. Use of a single implant with divergence of greater than 20 degrees from vertical is not recommended.

Root and Bar Attachments:

Not appropriate where a totally rigid connection is required.

Attachments for Multi-Unit Abutments:

Not appropriate where a totally rigid connection is required.

Retrofit for ERA Root Attachment:

Not appropriate for Micro ERA sized attachments or where a totally rigid connection is required.

CAUTION

Federal (USA) law restricts this device to sale by or on the order of a licensed dentist.

IMPORTANT INFORMATION ABOUT THE LOCATOR® ATTACHMENT SYSTEM (CONTINUED)

SINGLE-USE DEVICES

The LOCATOR Implant Attachment System components with the exception of the Tools (i.e. Core Tool, Spotface Diamond Bur, Pilot Drill, Drill & Tap Holder, Paralleling Mandrel, etc.) are single-use devices. If reused, Zest cannot guarantee the functionality nor the safety of the product. Zest accepts no responsibility for components re-sterilized by the user.

LOCATOR Males:

The inadvertent reuse of LOCATOR Males could cause loss of retention for the overdenture due to wear from previous use or damage during removal with the LOCATOR Core Tool.

LOCATOR Abutments (including Root and Bar Females):

The inadvertent reuse of these parts could result in improper fit of the Inserts due to wear of the retention band.

TOOLS

The LOCATOR Tools (i.e. Core Tool, Spotface Diamond Bur, Pilot Drill, Drill & Tap Holder, Paralleling Mandrel, etc.) are designed for multiple uses. If the tool becomes worn or damaged, obtain a replacement tool.

CLEANING

- Disassemble the instruments (i.e. Core Tool, Spotface Diamond Bur, Pilot Drill, Drill & Tap Holder, Paralleling Mandrel, etc.).
- Soak the instruments in enzymatic cleaning solution (mixed according to manufacturer's instructions) by completely submerging them for 20 minutes. Scrub the components using a soft-bristled, nylon brush until all soil has been removed.
- Remove the instruments from the enzymatic cleaning solution and rinse in tap water for a minimum of 3 minutes. Make sure to thoroughly flush internal holes/crevices of the instruments that have difficult to reach areas.
- If additional cleaning is needed, place instruments in ultrasonic cleaner (with enzymatic cleaning solution prepared according to manufacturer's instructions) making sure that they are completely submerged, and sonicate for 10 minutes.

- Remove the instruments from the ultrasonic cleaner, and rinse for 3 minutes making sure to thoroughly flush cleaning solution out of the holes/crevices and/or difficult to reach areas. Remove excess moisture from the instruments with a clean, absorbent, non-shedding wipe.

STERILIZATION

Wrap the components using a wrap that is FDA cleared for the indicated cycles. All components and instruments are supplied NON-STERILE.

LOCATOR Abutments and Instrumentation may be sterilized by Autoclave sterilization using the following parameters:

	Gravity Autoclave	Pre-Vacuum Autoclave
Temperature	132°C	132°C
Exposure Time	15 minutes	4 minutes
Dry Time	30 minutes	20 minutes

In order to ensure that the Males are sterilized/disinfected (all microorganisms including Clostridium sporogenes and Bacillus subtilis spores are eliminated), the Males must be soaked for a minimum of 3 hours in the liquid sterilant at room temperature.

NOTE: An FDA approved liquid chemical sterilant for critical devices that are heat sensitive and incompatible with sterilization methods such as steam and gas/vapor/plasma low temperature processes may be used following the manufacturer's directions for the sterilization of the device.

RETURN POLICY AND WARRANTY

ORDERING

Orders are accepted by internet, email, mail, fax, or phone. Regular business hours are 7:00am to 5:00pm PST (Pacific Standard Time). Domestic orders received by 1:00pm PST can be shipped by ground the same day. Orders received by 3:00pm PST can be shipped by express. Institutional orders require a purchase order number.

PRICING

Zest Dental Solutions makes every effort to maintain a competitive pricing structure. Pricing is subject to routine review and change without prior notice. All prices listed are in U.S. dollars.

TERMS AND BILLING

- A. Credit Card:** Payment at the time of order with VISA, AMERICAN EXPRESS, DISCOVER or MASTERCARD is necessary for customers not approved for open account billing or special financing offers.
- B. C.O.D.:** Delivery can also be made by C.O.D. freight collect.
- C. Open Account:** An open account can be established by completing a credit application and receiving approval by Zest Dental Solutions. The terms of orders purchased under open accounts are net 30 days.
- D. Export Orders:** Individual orders shipped outside the U.S. require payment in advance or a letter of credit.
- E. Past Due Accounts:** Past due balances will be subject to a 1.5% finance charge per month, amount equal to 18% per annum.

SHIPPING CHARGES

Merchandise is shipped prepaid by Zest Dental Solutions with the cost added to the invoice, or freight collect with C.O.D. fee included in the case of C.O.D. shipments. Delivery options include Fed Ex ground, 3-day, 2-day, or overnight rush service.

LIMITED WARRANTY

Zest Dental Solutions provides a limited warranty for its products, to the original purchaser, to be free from defects in workmanship and materials under normal use and service, for a period of one year from the date

of purchase. Zest Dental Solutions will, at its option, substitute the returned product that proves defective within the warranty period, with a similar product, free of charge.

Zest Dental Solutions continually strives to improve its products, and therefore, reserves the right to improve, modify, or discontinue products at any time without notice or incurring obligations. Purchaser assumes all risks and liability resulting from the use of Zest Dental Solutions Products, whether used separately or in combination with other products not of Zest Dental Solutions manufacture.

RETURN POLICY

Please Observe the Following Guidelines:

- A.** Authorization for returns must be received from Zest Dental Solutions prior to the return of any product. A Return Material Authorization (RMA) number will be provided for all returns.
- B.** Shipping charges must be prepaid by the customer to accept a return shipment.
- C.** Returned products are subject to a \$20 restocking fee for orders under \$400. For orders \$400 to \$1,000, a \$40 restocking fee will be applied. For orders exceeding \$1,000, please contact your Customer Service Representative for the restocking fee.
- D.** Returned merchandise will be accepted within 90 days of purchase if product is in saleable condition (in its original unopened package and not marred by any added writing or over-labeling).
- E.** Returns will not be accepted after 90 days of purchase.
- F.** Non-returnable items include:
 - 1. Merchandise retained beyond expiration date noted on the package.
 - 2. Packages with broken seals or missing parts
 - 3. Used, damaged, or obsolete products will not be accepted for return.

VISIT

ZESTDENT.COM

24 HOURS A DAY, 7 DAYS A WEEK

TO PLACE ORDERS ONLINE OR TO FIND
A LISTING OF ZEST DENTAL SOLUTIONS'
LOCATOR PARTNERS

**ZD ZEST DENTAL
SOLUTIONS™**

ZEST | DANVILLE MATERIALS | PERIOSCOPY

ZEST DENTAL SOLUTIONS
2875 LOKER AVENUE EAST
CARLSBAD, CA 92010 USA
WWW.ZESTDENT.COM

TOLL FREE: 1.800.262.2310
DIRECT: 1.442.244.4835
FAX: 760.743.7975
EMAIL: SALES@ZESTDENT.COM

DISTRIBUTED BY:

EC REP
Wellkang Ltd
29 Harley St.
W1G 9QR
London U.K.

CE
0086